

COMMISSIONING

Mounting

- The transmitter should be installed above the measuring point to avoid condensation problems.

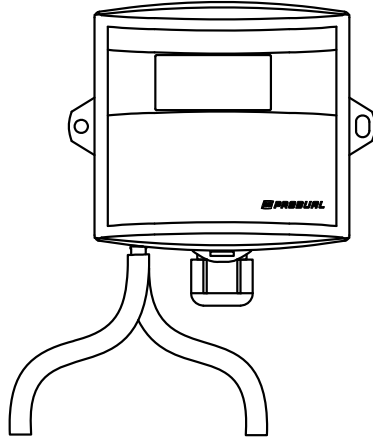

- The duct overpressure is detected by connecting the measuring point to + connector and by leaving the - connection open (surrounding space pressure). Accordingly, the duct under-pressure is detected by connecting the measuring point to - connector and by leaving the + connection open.
- Install the measuring hoses carefully so that the hoses don't bend too tightly. Too tight curves may prevent the air flow to the sensor.

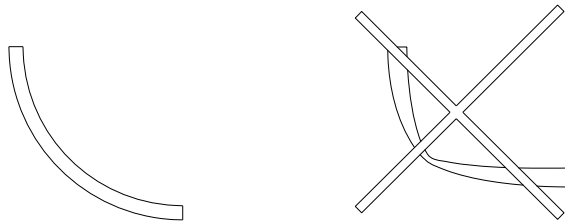

- The hose length doesn't effect on the measuring accuracy. However, long hoses generate delay on the measurement.

Wiring



Device wiring and commissioning can only be carried out by qualified professionals. Always make the wirings while the power is switched off.

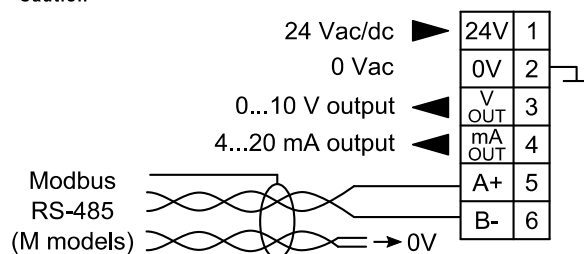

Selecting the measuring range

The measuring range can be selected with the jumpers S2, S3 and S4.

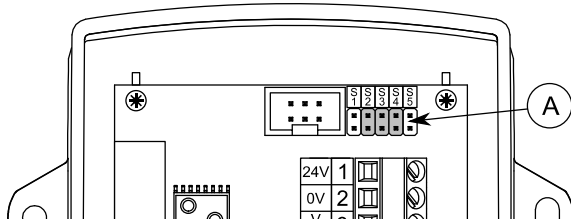

A. Pressure selection jumpers

	0...1000	0...1500	0...2000	0...2500	0...3000	0...4000	0...5000	0...8000 ^{*)}
S2	• •	■	• •	■	• •	■	• •	■
S3	• •	• •	■	■	• •	• •	■	■
S4	• •	• •	• •	• •	■	■	■	■

^{*)} Factory setting. The 0...8000 Pa range is also used for the custom range setting.

The custom range is 0...8000 Pa as a default. The range can be changed by using ML-SER tool or by defining the high limit to the Modbus register 40002 (the low limit is 0 Pa).

Selecting the time constant

The time constant can be selected with the jumper S1.

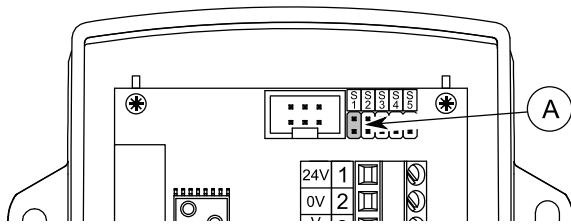

A. Time constant selection jumper

	2 s	8 s ^{*)}
S1	• •	■

^{*)} Factory setting.

Selecting the output mode

The transmitter output can be either pressure linear or flow linear. The output mode can be selected with the jumper S5.

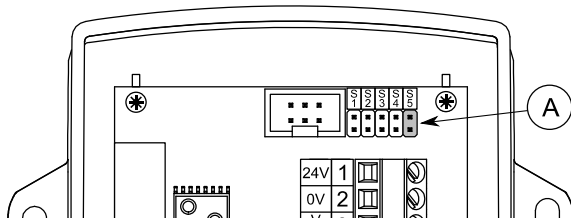

A. Output mode selection jumper

	pressure linear ^{*)}	flow linear
S5	■	• •

^{*)} Factory setting.

Flow linear output

When the flow linear output is selected, the transmitter outputs are converted to follow the flow across the measurement area. The conversion is made by using square root extraction method.

See the following figure for the output example in the 0...1000 Pa range:

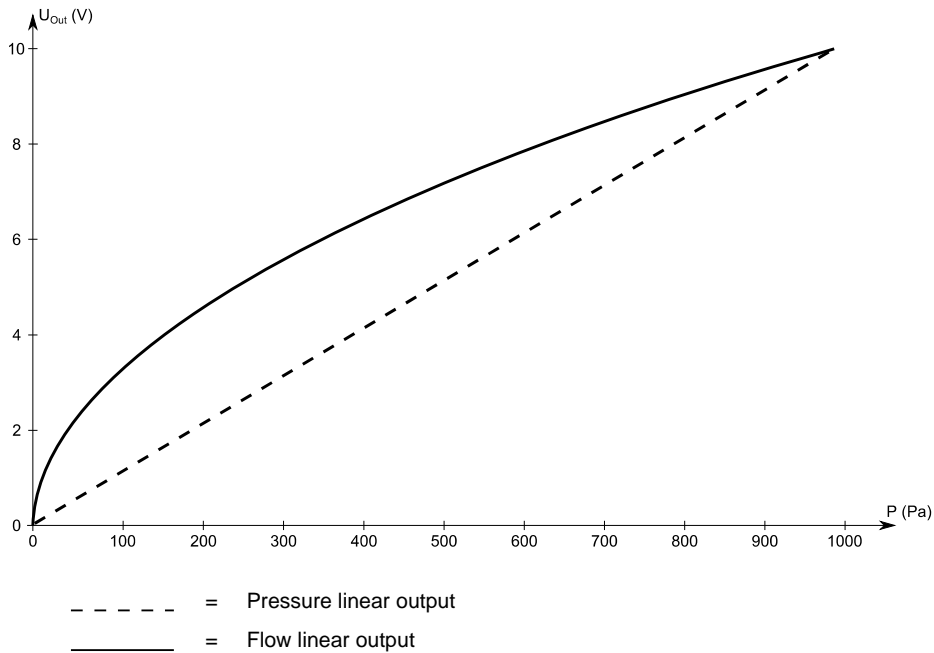

ZERO POINT CALIBRATION

The purpose of the zero point calibration is to remove the possible long term drift. The zero point is calibrated automatically every five minutes.

NOTE: The zero point calibration is also executed on the start-up and a minute after the start-up.

ML-SER TOOL

With the ML-SER tool you can change the device settings, Modbus settings for example.

Connecting ML-SER tool to the device

1. Remove the cover.
2. Disconnect the display cable (N models).
3. Connect the ML-SER tool cable to the display connector.

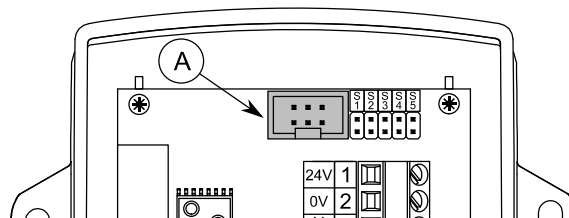

A. Display connector

When the ML-SER is successfully connected, the pressure measurement value is displayed on the ML-SER tool display. The connecting can take few seconds.

ML-SER menu

The device settings can be changed by using ML-SER tool. You can proceed in the menu by pressing the M and OK buttons. The values can be changed with the "+" and "-" buttons. The value is accepted with the OK button. The settings are saved when exiting the menu. The following menu structure contains the factory settings.

The Modbus and analogue outputs are disabled when entering the menu for the measuring mode. In addition the analogue outputs maintain the same voltage, as they were before entering the menu.

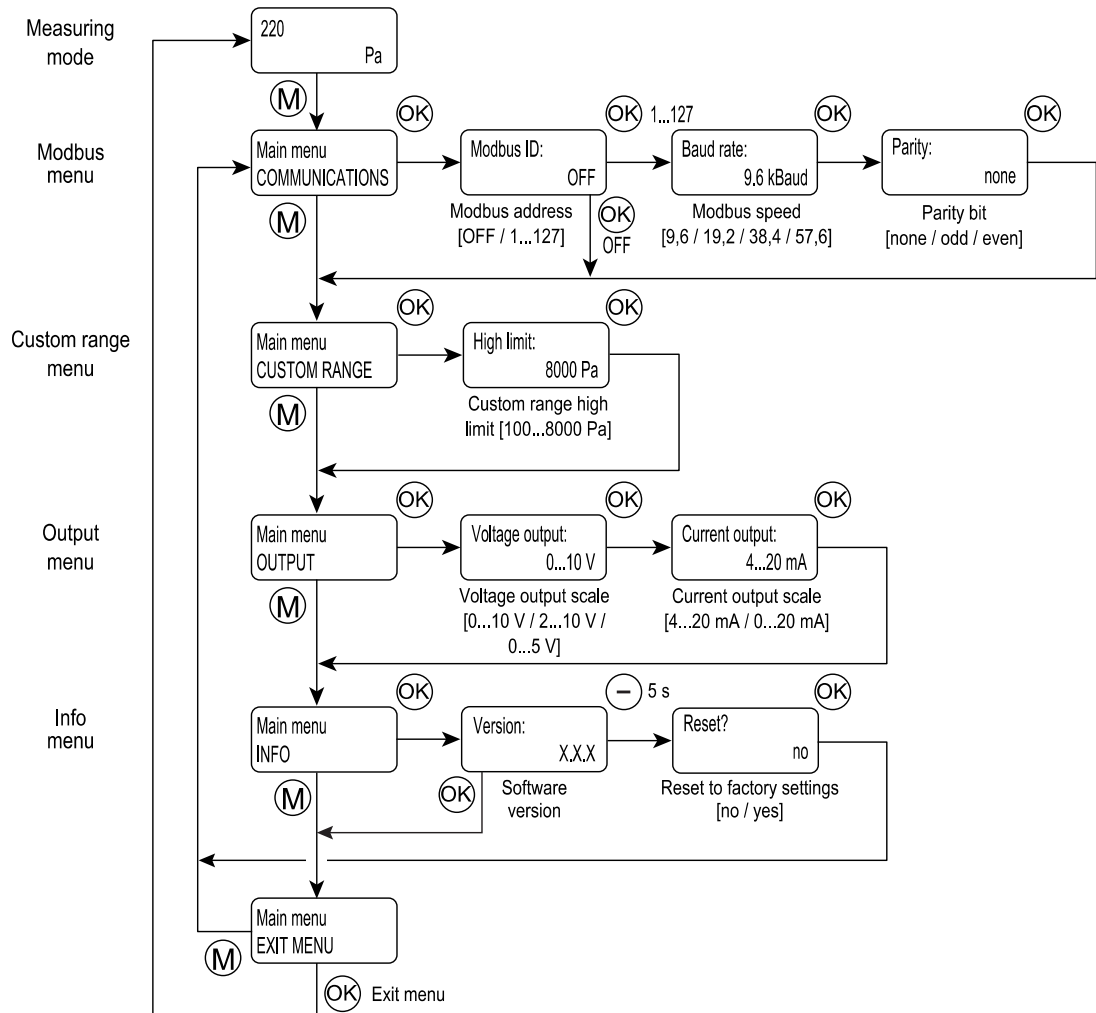

Communications menu (M models only)

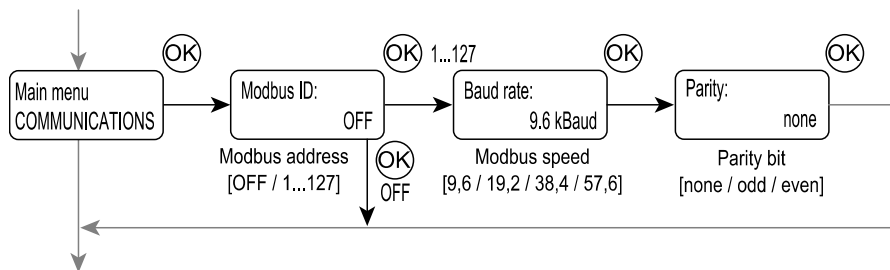

The Modbus settings can be changed through the COMMUNICATIONS menu.

Custom range menu

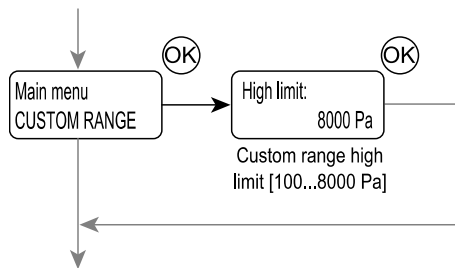

The CUSTOM RANGE menu is for setting the custom pressure range high limit. The custom range is in use when all the pressure range selection jumpers are placed.

Output menu

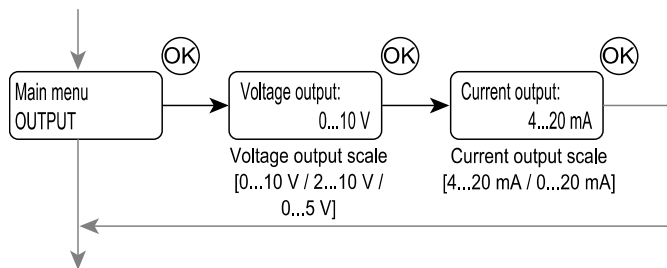

You can change the measurement output scales through the OUTPUT menu.

Info menu

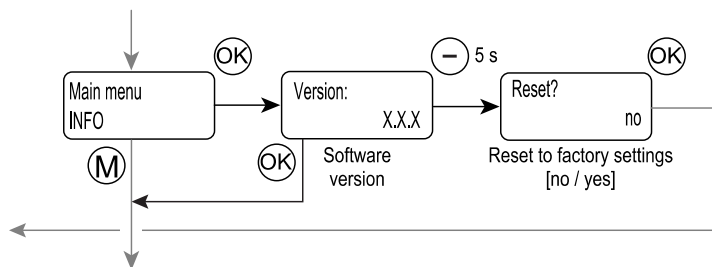

The INFO menu can be used for checking the software version and resetting to the factory settings.

Resetting to the factory settings

1. Press the "-" button for five seconds in the software version display.
2. Change the resetting dialog answer to "yes".
3. Press OK button.

The factory settings are now reset.

MODBUS

Bus properties

Protocol	RS-485 Modbus RTU
Bus speed	9600/19200/38400/57600 bit/s
Data bits	8
Parity	none/odd/even
Stop bits	1
Network size	up to 127 devices per segment

NOTE: The memory durability is 10000 write cycles.

Bus termination

The Modbus can be terminated by placing the Modbus termination jumper.

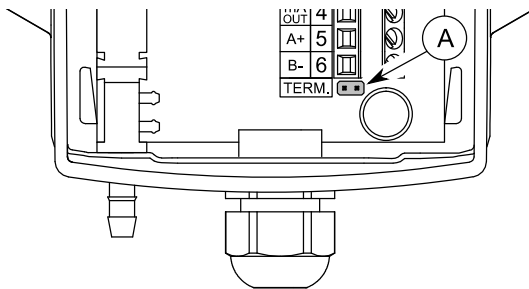

A. Modbus termination jumper

Supported Modbus functions

0x01	Read Coils
0x02	Read Discrete Inputs
0x03	Read Holding Registers
0x04	Read Input Registers
0x05	Write Single Coil
0x06	Write Single Register
0x0F	Write Multiple Coils
0x10	Write Multiple Registers
0x17	Read/Write Multiple Registers

Modbus registers

Data type:

bit = 0 or 1
 unsigned = unsigned integer (0...65535)
 signed = integer (-32768...32767)

Input registers (read only)

Register	Parameter description	Data type	Value	Range
30001	Pressure measurement	signed	-32768...32768	-32768...32768 Pa
30002	Time constant	unsigned	0..60	0..60 s
30003	Selected pressure range	unsigned	0...7	0 = 0...1000 Pa 1 = 0...1500 Pa 2 = 0...2000 Pa 3 = 0...2500 Pa 4 = 0...3000 Pa 5 = 0...4000 Pa 6 = 0...5000 Pa 7 = 0...8000 Pa / custom *)
30004	Measurement output	signed	0...1000	0...100,0 %

*) The custom range is 0...8000 Pa as a default. The range can be changed by using ML-SER tool or by defining the high limit to the Modbus register 40002 (the low limit is 0 Pa).

Holding registers (read / write)

Register	Parameter description	Data type	Value	Range	Default
40001	Not in use	signed	-	-	0
40002	Custom scale high limit	signed	1...80	100...8000 Pa	80
40003	Voltage output scale	unsigned	0 - 1 - 2	0 = 0...10 V 1 = 2...10 V 2 = 0...5 V	0
40004	Current output scale	unsigned	0 - 1	0 = 4...20 mA 1 = 0...20 mA	0